

Design, analysis and investigation of an independent suspension for passenger cars

BELLUOMO, Carlo, LENZO, Basilio <<http://orcid.org/0000-0002-8520-7953>>, BUCCHI, Francesco and VELARDOCCHIA, Mauro

Available from Sheffield Hallam University Research Archive (SHURA) at:

<http://shura.shu.ac.uk/22809/>

This document is the author deposited version. You are advised to consult the publisher's version if you wish to cite from it.

Published version

BELLUOMO, Carlo, LENZO, Basilio, BUCCHI, Francesco and VELARDOCCHIA, Mauro (2018). Design, analysis and investigation of an independent suspension for passenger cars. In: CARBONE, Giuseppe and GASPARETTO, Alessandro, (eds.) Advances in Italian Mechanism Science: Proceedings of the Second International Conference of IFToMM Italy. Mechanisms and Machine Science, 68 (68). Netherlands, Springer, 165-173.

Copyright and re-use policy

See <http://shura.shu.ac.uk/information.html>

Design, Analysis and Investigation of an Independent Suspension for Passenger Cars

Carlo Belluomo^{1,2}, Basilio Lenzo^{2*}, Francesco Bucchi³, Mauro Velardocchia⁴

¹ Politecnico di Torino, Italy, e-mail: carlobelluomo@hotmail.it,
mauro.velardocchia@polito.it

² Sheffield Hallam University, UK, e-mail: basilio.lenzo@shu.ac.uk

³ Università di Pisa, Italy, e-mail: francesco.bucchi@unipi.it

Abstract. The objective of this paper is the design of a front suspension. The layout used is the McPherson strut, widely adopted for road cars due to its simplicity and to the limited space required. The handling, comfort and durability of the suspension are strictly related to the position of the hardpoints, and to the elastic elements. A sensitivity analysis is carried out to investigate the roll behavior of a standard vehicle during cornering. A multi-body dynamics software is used to perform ramp-steer simulations on a full-vehicle model. Results show the different peculiarities of three specific cases of analysis, each of them emphasising the effects of a specific parameter on the whole system.

Keywords: suspension, McPherson, roll centre, simulations, sensitivity analysis

1 Introduction

The research of the best performance in a vehicle has been investigated for a long time. Regardless of the size and the power of the engine, the performance of the vehicle is highly dependent on the ability to transmit the torque produced by the engine to the ground via tire-road contact forces. The suspension system is a key component of a vehicle, as it allows the vehicle to comply with uneven road surfaces, ensuring a good tire-road contact and reducing vibrations [11]. The design of a suspension system is unique for each type of car and differs for the various uses the car should deal with. The recent development in electronics and control has made it possible to control the motion of the suspension varying its response dynamically depending on the road conditions, using active or semi-active systems. However these kinds of solutions are still expensive and their use is limited. An interesting recently-developed technique for the enhancement of vehicle performance is torque vectoring, either to achieve a direct yaw moment [14-15], or looking at the front-to-rear torque distribution [1-3,5], however that also relies on the ability of transferring desired amounts of force between tire and

road, which requires an appropriate suspension system. One of the most used suspension layout for medium level vehicle is the McPherson layout because of its simplicity of design, low cost, and easiness to be adjusted. The performance of a suspension depends indeed on several parameters, such as roll centre height, camber gain, toe change during bump, scrub radius, caster angle and many more [7,10]. Because of such a complexity, the achievement of different performance objectives is likely to be contradictory, making it necessary to find an optimal compromise [8]. It should also be taken into account that the design of the elastic components is somewhat limited due to comfort issues related to human perception limits [4]. The complexity of the design requirements of a vehicle suspension can be addressed using advanced multi-body dynamics software, such as Adams/Car. Such software allow to simulate the motion of the suspension in several conditions and to use optimization algorithms to find the best layout configuration improving the performance of even a simple layout such as the McPherson [12-13].

The objective of this paper is the design and sensitivity analysis of a front McPherson layout. The design is based on basic vehicle data including mass, wheelbase and track. The paper presents a methodology applied for the design of the suspension and proposes a sensitivity analysis, investigating the influence of different layout configurations and elastic components on the roll behavior during cornering through a ramp steer maneuver performed with Adams/Car.

2 Kinematic design

The design of the suspension started from the main geometric parameters of a commercial car. The roll centre analysis was the first target. In a vehicle front view, the roll centre lies on the intersection between two lines: i) the line between the centre of the contact patch of the tire and the instant centre of rotation, according to Kennedy's theorem [6]; ii) a vertical line of symmetry of the vehicle [11]. The instant centre is obtained as the intersection between the line defining the lower control arm and line perpendicular to the strut [11]. A target roll sensitivity of 5 deg/g was set, together with a desired front roll centre height of 120 mm. Considering that the height and the inclination of roll axis depends on the roll centre height at the front and rear axle [4], the height of the roll axis in correspondence with the vehicle centre of gravity was fixed at the 30% of the centre of gravity height. A 40% ratio between the front and rear roll centre height was chosen, and as consequence the roll centre height for each axle was obtained. Despite this work focuses on the front suspension, the rear suspension was set to match the roll sensitivity target. The kinematic design was run in parallel with the design of the elastic components that affects the dynamic of the vehicle. Olleys' criteria were followed to define spring stiffness [4]. Anti-roll bars stiffness values were defined by imposing the same amount of lateral load transfer for each axle.

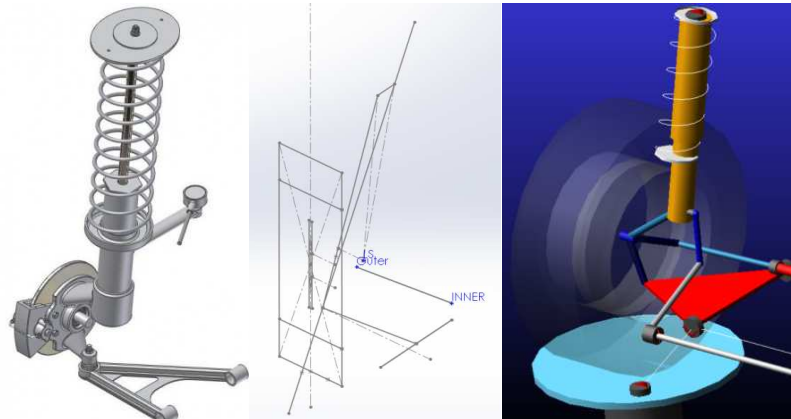

Fig. 1 McPherson layout (left), Solidworks model (centre), Adams model (right)

In order to choose the position of the main hardpoints, a SolidWorks model was developed, composed of different planes used to draw the 3-D model of the suspension, Fig. 1. A parametric approach was chosen, so as to be able to change main suspension parameters, e.g. kingpin angle, caster angle, lower arm inclination angle, with the model automatically recalculating the position of the instant centre and roll centre accordingly. The majority of sensitivity analysis carried out implies to vary the position of the hardpoints whilst maintaining the desired value of roll centre height. Indeed, parameters such as the inclination of the strut and the position of the lower ball joint (knuckle side) have influence on the position of the instant centre and on the scrub radius. For instance, large kingpin angles lead to large values of scrub radius which is generally not beneficial for riding and comfort, but they can positively affect the vehicle braking performance [9,11].

For the sensitivity analysis presented in this paper, 3 main cases were investigated. Each of them involved to change some key parameters, keeping other parameters constant. The performance of 5 different configuration sets for each of the 3 cases was compared simulating ramp steer maneuver on Adams\Car. The 3 different cases are detailed in Table 1. In the first case study, the strut inclination and the lower arm inclination angle are changed, keeping the same roll centre height - the kingpin angle and the instant centre position change as a consequence. The second case concerns the variation of the anti-roll bar stiffness only. The third case looks at the variation of the vertical position of the lower arm outer ball joint, maintaining the same strut inclination and anti-roll bar stiffness.

3 Implementation and simulation on ADAMS

Based on the design parameters, a vehicle model was implemented on Adams/Car (Fig. 2). For each of 3 case studies, a ramp steer maneuver was run at 70 km/h and with a 10 deg/s steering wheel angle rate.

Table 1. Details of the three cases analysed

<i>Parameter</i>	<i>Case 1</i>	<i>Case 2</i>	<i>Case 3</i>
Strut inclination	Variable	Constant	Constant
Kingpin angle	Variable	Constant	Variable
Instant centre position	Variable	Constant	Variable
Lower arm inclination angle	Variable	Constant	Variable
Roll centre height	Constant	Constant	Variable
Anti-roll bar stiffness	Constant	Variable	Constant

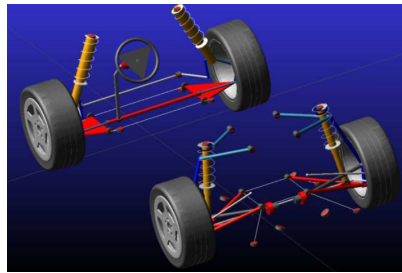
**Fig. 2** The Adams/Car model developed

3.1 Case 1

In this case study, 5 different configurations of strut inclination and lower arm inclination angle were obtained exploiting the developed Solidworks model, keeping the same roll centre height (Table 2). Different lower arm inclination angles lead to different instant centre positions. The position of the instant centre can be seen as the length of an equivalent swing arm suspension scheme. Such length influences the camber gain, as a shorter length implies a larger camber gain that counteracts the camber change due to body roll. Also, the inclination of the strut affects the magnitude of the vertical component of the force exerted by the springs. Increasing the inclination of the strut, the vertical component reduces, and the suspension roll rate decreases as a consequence, increasing the body roll.

Fig. 3 depicts camber angle and body roll angle for each configuration, as a function of lateral acceleration. The static camber was set to -1 deg. The first configuration presents the smallest camber variation, due to the shortest swing arm length causing a larger camber gain. Conversely, the body roll for such configuration is the greatest. Among the five configurations, the difference in camber angle is more significant than the difference in body roll, that is because the anti-roll bar stiffness is significantly higher than the roll stiffness due to the springs. As a result, a larger lateral force can be produced in the first configuration [4], with a smaller radius of curvature, Fig. 4.

Table 2. Case 1 parameters

Conf. no.	Kingpin angle (deg)	Lower arm angle (deg)	Swing arm length (mm)	Strut inclination (deg)	Scrub radius (mm)	Anti-roll bar stiffness (kN mm/deg)
1	26.3	2	2103	23.10	-52	40
2	19.19	4	3020	12.75	-21	40
3	15.76	5	3876	7.78	-11	40
4	12.385	6	5431	2.91	7.6	40
5	10.73	6.5	6807	0.54	13.7	40

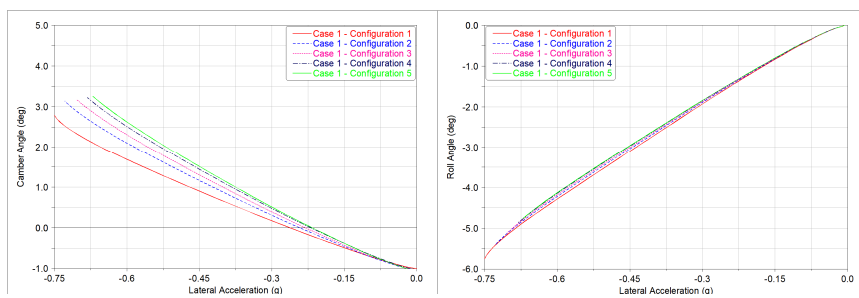

Fig. 3 Case 1: (left) camber angle and (right) body roll, for 5 different configurations

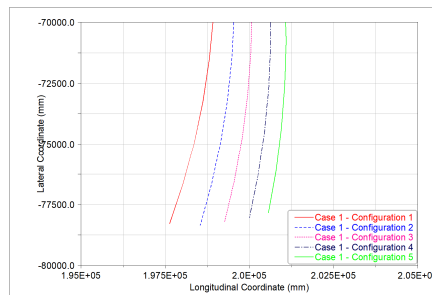

Fig. 4 Case 1: trajectory for 5 different configurations

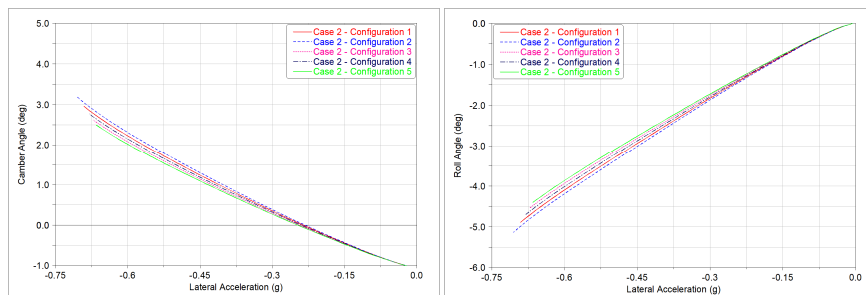

Fig. 5 Case 2: (left) camber angle and (right) body roll, for 5 different configurations

3.2 Case 2

The second case study involves the variation of the anti-roll bar stiffness maintaining all the other parameters, chosen as follows: kingpin angle 15.8 deg, caster angle 5 deg, lower arm angle 0 deg, swing arm length 3876 mm, strut inclination 7.8 deg, scrub radius -11 mm. The 5 values of anti-roll bar stiffness are: (4, 4.5, 5, 5.5, 6) $\times 10^5$ N mm/deg, corresponding respectively to configurations 1, 2, 3, 4, 5. Fig. 5 shows that increasing the stiffness, the roll angle is reduced and the camber angle is reduced as well. Increasing the torsional stiffness at the front axle, the roll stiffness ratio between front and rear axle increases. This increases the lateral load transfer at the front axle, hence the front right wheel withstands an increased vertical load. The total lateral force at the front axle is then reduced due to the nonlinear tire characteristic [4]. This means that during the maneuver, the vehicle with the highest anti-roll bar stiffness negotiates a wider trajectory, Fig. 6.

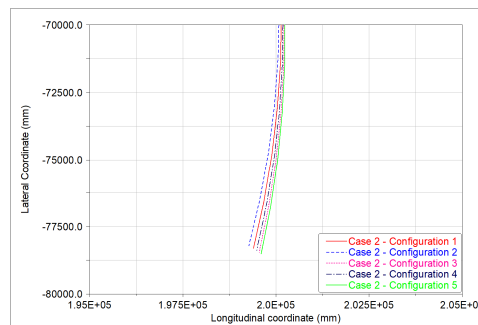

Fig. 6 Case 2: trajectory for 5 different configurations

3.3 Case 3

In the third case study, the outer ball joint of the lower control arm is moved vertically, making the lower arm inclination change. Changing the lower arm inclination, the instant centre position and the roll centre height change. Table 3 shows the parameters adopted for each configuration. As the roll centre height increases, the vehicle experiences a reduced roll angle, as shown in Fig. 7 (right). At the same time, as the instant centre distance from wheel centre decreases, the camber gain improves as shown in Fig. 7 (left). Therefore, moving from configuration 1 to 5, the attainable lateral force increases and the trajectory of the car gets narrower (Fig. 8).

Table 3. Case 3 parameters

Conf. no.	Outer ball joint height from ground (mm)	Roll centre height (mm)	Swing arm length (mm)	Kingpin angle (deg)
1	295.55	-48	29226	14.95
2	270.55	27	8360	14.5
3	245.55	98	5017	14
4	220.55	164	3651	13.68
5	170.55	284	2442	12.9

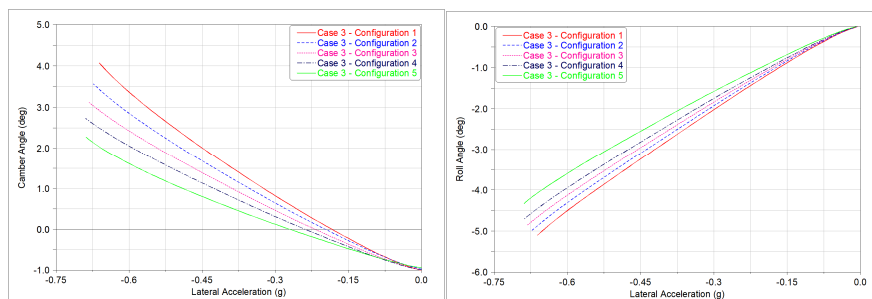
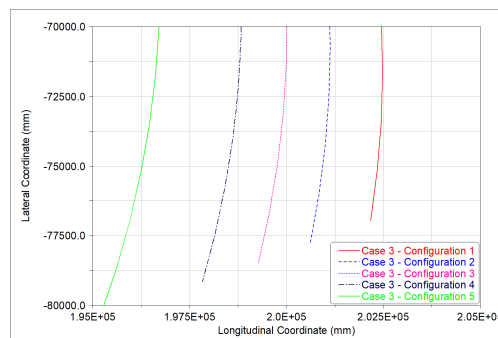
**Fig. 7** Case 3: (left) camber angle and (right) body roll, for 5 different configurations**Fig. 8** Case 3: trajectory for 5 different configurations

4 Conclusion

The design process of a McPherson front suspension was presented. Starting from initial vehicle data, a geometrical approach was investigated on Solidworks, which was then validated via the multibody dynamics software Adams\Car. A full vehicle model was then implemented on Adams\Car. A sensitivity analysis was conducted on a standardised ramp steer maneuver, changing some key hardpoints of the suspension and some elastic parameters. The effects of individual parameters

on body roll, camber gain and trajectory was investigated, providing critical insights concerning the design of a passenger car suspension. Case study 1 showed that a more compact geometry, desirable for layout issues especially in small cars, having the strut almost vertical (configuration 5), could bring to a reduction of the vehicle performance in terms of lateral acceleration, without considerably affecting the vehicle roll, which is in turn a layout but also a comfort parameter. However, Case study 2 and 3 showed that if the vehicle roll is changed, both with layout-independent parameter, i.e. the roll bar stiffness, or with suspension geometry parameters, the vehicle performance could be rebalanced. In conclusion, considering the case studies, it is clear how the suspension geometry allows layout, performance and comfort tuning and, in a real vehicle, the trade-off between these requirements could be found based on the design specifications.

References

1. Bucchi, F., Lenzo, B., et al.: The effect of the front-to-rear wheel torque distribution on vehicle handling: an experimental assessment. IAVSD 2017, Australia (2017)
2. Bucchi, F., Frendo, F.: A new formulation of the understeer coefficient to relate yaw torque and vehicle handling. *Vehicle System Dynamics* 54, no. 6: 831-847 (2016)
3. De Filippis, G., Lenzo, B., et al.: Energy-Efficient Torque-Vectoring Control of Electric Vehicles with Multiple Drivetrains, *IEEE Transactions on Vehicular Technology* (2018)
4. Guiggiani, M.: *The Science of Vehicle Dynamics*. Springer (2014)
5. Lenzo, B., De Filippis, G., et al.: Torque Distribution Strategies for Energy-Efficient Electric Vehicles with Multiple Drivetrains, *ASME J. of Dyn. Syst., Meas. and Control*, 139:12 (2017)
6. Mata, A.S., Torras, A.B., Carrillo, J.A.C., Juanco, F.E., Fernández, et al.: *Fundamentals of machine theory and mechanisms (Vol. 40)*. Springer (2016)
7. Milliken, W.: *Race Car vehicle dynamics*. Society of Automotive Engineers (1995)
8. Morales, E.: Sensitivity study of front suspension parameters in elastokinematics and handling behavior of a vehicle. *Society of Automotive Engineers*, 2016-36-0182 (2016)
9. Reimpell, J., Stoll, H. and Betzler J.: *The Automotive Chassis: Engineering Principles*. Butterworth-Heinemann (2001)
10. Rocca, E., Timpone, F.: Analysis of multilink suspension characteristics due to the rods length variations. *Proceed. of the world congress on engineering 2*, pp. 107-1021 (2016)
11. Smith, J.: *An introduction to Modern Vehicle Design*. Butterworth-Heinemann (2002)
12. Taehyun, S. and Pradheep, C.: Influence of Suspension Properties on Vehicle Roll Stability. *Society of Automotive Engineers*, 2006-01-1950 (2006)
13. Timpone, F.: A physical analytical model to study the elasto-kinematic behaviour of a macpherson suspension. *Advances in Italian Mechanism Science*, pp. 491-501. Springer (2017)
14. Tota, A., Lenzo, B., Lu, Q., Sorniotti, A., Gruber, P., Fallah, S., Velardocchia, M. et al.: On the experimental analysis of integral sliding modes for yaw rate and sideslip control of an electric vehicle with multiple motors. *Int. Journal of Automotive Technology* (2018)
15. Wang, Z., Montanaro, U., Fallah, S. et. al.: A gain scheduled robust linear quadratic regulator for vehicle direct yaw moment Control. *Mechatronics*, 51, pp.31-45 (2018)